



# Owner's Manual

## Light-Duty Appliance Mover

### Covers Appliance Mover Models:

Model No.	Description	Lift rating (lbs.)	Speed	Vacuum Capability
AM1200-VS	Light Duty Appliance Mover	450	Variable	No

NOTE: This manual references models with a 120V blower and "B" type electric plug. This manual is also valid for 220V Airsled systems sold with the respective, country/region-specific electrical cord/plug sets. The models are denoted with an EU or UK or AU in the model number.

## SAFETY INSTRUCTIONS FOR USE

- Airsled systems can move countless objects provided that the appropriate conditions exist, and that the load's weight is within the system's maximum lifting capacity. These conditions include the following:
  - ✓ Surface is level and free of incline and/or decline. DO NOT attempt using your Airsled system on inclines, declines, ramps or stairs.
  - ✓ Surface is smooth and non-porous and free of debris. Porous surfaces such as carpeting requires use of Airsled's Rough Surface Adapters (RSAs).
  - ✓ Load's weight is evenly distributed. If not the case, the air beams may need to be positioned in a manner to help offset the uneven weight distribution (e.g. closer to the heavier side of the load).
  - ✓ Lower center of gravity is better. Attempting to move an object with a high center of gravity may result in undesirable tilting when lifted leading to a tipping hazard. If moving an object with a high center of gravity, ensure adequate support is present to offset any tilting.
- Keep all parts of the body, especially hands and feet, away from underneath the air beams and the load being lifted while operating your Airsled.
- DO NOT stand or ride on the air beams.
- To avoid electric shock, do not use in damp or wet locations. Do not expose the blower to water or other liquids. Use only grounded power cords and outlets.

## AIRSLED APPLIANCE MOVER COMPONENTS

Qty	Description
2	Aluminum air beams*
1	Blower with variable speed control
1	Shoulder strap
1	Tee connector
2	Supply hoses that connect to the air beams
1	Lead hose that connects to the blower
4	Rough Surface Adapters (RSAs)
1	Carrying bag for your complete system

Please see **Exhibit 1** for a detailed system diagram to order replacement parts.

\* **IMPORTANT** Standard Appliance Mover air beams are 9" W x 36" L and are recommended for loads up to 32" deep. If the load's depth is greater than 32", Airsled's XL air beams which are 9" W x 39" L are recommended to more effectively maximize how much of the air beam's surface is completely under the entire load due to the inlets.

## BEFORE USING THE AIRSLED APPLIANCE MOVER

- Remove objects from the top and inside of the load you plan to move to prevent damage.
- Shut OFF or disconnect any gas, electric or water that may be connected to the load.
- Nonstructural features prone to bending near the load's base such as grill covers should be removed; the air beams should only make contact with the load's structural frame during movement.
- Verify that no other features or fixtures (e.g. hoses, drip pan, connectors, flanges) hang down from the load's base that may prevent the air beams from making contact directly with the structural frame.
- Because an Airsled will elevate the load, measure the overhead clearance between the highest point of the load and any overhead objects such as cabinets. If less than 2", please see the **Control and Maneuverability** section.
- If your model has Variable Speed (VS) performance, you will be able to control the rate and height of air beam inflation for greater control and safety in tight, overhead clearance situations.

## POSITIONING THE AIR BEAMS

- Appliance Mover air beams are 1/8" thick. There must be enough clearance between the floor and the load's base to allow the air beams to be freely slid into place. DO NOT force the air beams under the load.
- If the gap between the air beam and load's base is greater than 1 1/2", the air beams may not produce the necessary lift. To address this issue, Airsled offers SPACER STICKS and ADJUSTABLE SPACER SYSTEMS. More information on these items can be found on [www.Airsled.com](http://www.Airsled.com). Wood blocking can also be used to bridge the gap.
- Slide the air beams under the load. See figure 1.
- Placement of the air beams will generally be done either through front or side access. See figure 2 & 3. Optimal Airsled performance will be achieved by centering the air beams under the load so that the same length of air beam extends from the front as well as the back. Pushing the air beams as wide apart as possible is also recommended.

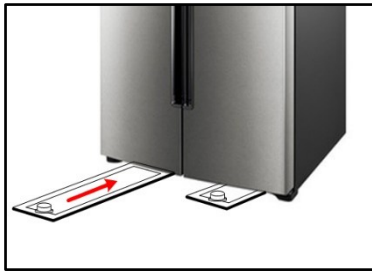

Figure 1

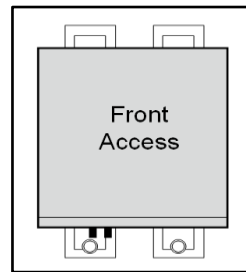

Figure 2

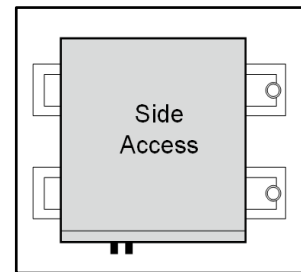

Figure 3

- The air beams for the Light Duty Appliance mover are 7" wide x 36" long and are recommended for loads whose base exceed 32" in length.

## CONNECTING THE AIRSLED COMPONENTS

- No tools are required to connect or disconnect the Airsled components. All connections between the blower, lead hose, Tee connector, supply hoses and air beam inlets should be done by hand until a snug fit. See figure 4.

**NOTE:** When connecting or disconnecting the supply hoses to the air beams, do so by grabbing the:

**Solid hose end**

**Solid plastic inlet**

Pulling only the soft hoses may damage your system.



Figure 4

## OPERATING YOUR AIRSLED

- Once the air beams are in position and all connections are snug, you are ready to plug your system into a grounded electrical outlet.
- Strap the blower comfortably over your shoulder and engage the power switch.
- **BE PREPARED** to brace and control the load once your Airsled system is activated. Using both hands to control and maneuver the load at all times is recommended. See figure 5.



Figure 5

## CONTROL AND MANEUVERABILITY

- All Airsled systems have an air flow controller. See figure 6. By fully opening the controller, less air will flow into the air beams. This can help reduce the lift especially in situations where overhead clearance is limited (e.g. less than 2”).
- Dial-controlled, **VARIABLE SPEED** performance can control the rate and height of air beam inflation making the load less likely to get wedged due to tight, overhead clearance. If clearance is less than 1”, it is recommended you turn up the air flow gradually.
- **Tilting** may occur if the load is not optimally positioned over the air beams (e.g. object is up against a wall and air beams only extend slightly through the rear). If the load tilts away from you, you can use the Airsled foot brace by laying it across the rear of the air beams and applying downward pressure with your foot. See figure 7. If the load tilts toward you, the air beams may be pushed under too far and will need to be pulled back. If the load tilts to the side, you may need to shift one or both of that air beams to offset the tilt.



Figure 6



Figure 7

## GOING OVER POROUS SURFACES SUCH AS CARPETING

All Airsled systems come with plastic Rough Surface Adapters (RSAs). The RSAs are 8” W x 36” L and laid on top of the porous surface, such as a carpet. The air beams **MUST BE PLACED OVER THE RSAs** in order for your system to perform properly. See figure 8. Your system comes with 4 RSAs allowing you to create a short track to move the load. If moving the load over long distances, heavy cardboard paper such as Ram Board® floor protection paper can be used. See figure 9.



Figure 8



Figure 9

## CARE AND MAINTENANCE

Airsled systems are proudly made in the USA using the highest quality materials. If properly used and maintained, your Airsled product will have a long service life. To ensure optimal performance and longevity, we recommend the following:

- Keep the edges of the air beams from striking hard objects.
- When moving or repositioning the air beams, avoid dragging the corners.
- Avoid lifting and carrying the air beams by the inlets. Carrying the air beams by only the inlets may cause them to come loose over time.
- Periodically inspect the blower filter and bag depending on model. These components should be cleaned to ensure peak performance of the system's blower.
- Check the rubber fabric for rips and dirt. If dirty, water with a mild detergent can be used to clean them as well as household cleaning sprays such as Windex®. To restore the rubber fabric's shine, Armor All® is recommended.
- If you find any rips in the fabric, please see the Repairs and Refurbishment section.

## REPAIRS AND REFURBISHMENT

Wear and tear over time especially with frequent use may cause components to fail. Airsled offers refurbishment services that can restore your aluminum air beams to as-new condition. More information can be found on [www.Airsled.com](http://www.Airsled.com). Due to safety and regulatory concerns, Airsled cannot refurbish the blower. Airsled also sells replacement parts. Please see detailed parts list in Exhibit 1. Any repairs performed by the end-user should be considered temporary. We recommend contacting Airsled to determine the proper course of action based on the nature of the issue. Some common, temporary repairs that can be performed in the field include:

**Rips in the rubber fabric.** Small rips can be temporarily repaired with duct or electrical tape. Before applying tape, the area must be cleaned and dried. We recommend returning your air beams to Airsled to be fully refurbished if rips are discovered.

**Cracked hose inlet.** If you notice a crack in the plastic inlet connected to the air beam, you can wrap the outer edge in tape after the surface has been cleaned and dried. We recommend that you replace the inlet which Airsled sells.

**Loose hose connections.** Over time, the soft ends of the hoses may become stretched out causing them to lose their snug fit. You can temporarily wrap the male ends with tape to establish a tighter seal. We recommend that you replace the hoses which Airsled sells.

## MINOR PRODUCT VARIANCES DUE TO HAND-MADE NATURE OF COMPONENTS

Airsled systems are made by hand to exacting specifications. Because each air beam is made by hand, you may see very minor differences in how the rubber fabric is folded and glued around the aluminum at the edges. You may also notice some glue residue on the aluminum and/or rubber fabric. Because of the fabrication and storage process, there could also be minor scratches or scuff on the aluminum or rubber.

### AIR LEAKAGE DURING USE

You may observe some minimal air leakage at the folded corners during operation. This is completely normal and does not impact or reduce the system's performance.

Due to extreme internal air pressure and because the Airsled blower is not a completely sealed device, air leakage from the bower during operation is also normal and does not impact Airsled performance.

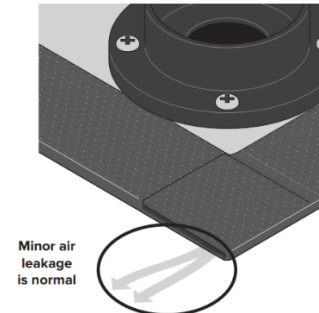

### METAL MEMORY LEADING TO SLIGHT BOWING OF AIR BEAMS

All Airsled aluminum air beams start off as a massive coil before being cut and processed into the final, rectangular panels. During the processing steps, the internal, stored energy of the aluminum is released which may lead to minor bowing in some of the rectangular panels. This phenomenon is called "metal memory" where the metal wants to revert to its original shape from being coiled. This slight bowing due to metal memory is normal and does not impact product performance. When placing the air beam under a load, simply press with your hand to flatten out the air beam and offset the bowing.

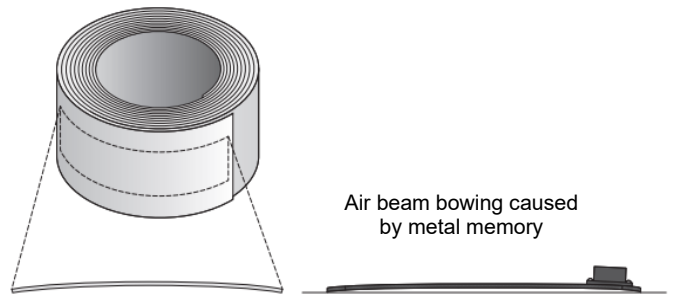

### IMPORTANT! PROPER HANDLING OF THE HOSES TO AVOID DAMAGE

When attempting to dislodge the hoses from the air beams, **DO NOT** pull on the actual hoses. Only pull by first gripping the hard plastic hose end as shown in the **CORRECT** image at right. Pulling on the actual hoses may damage them or cause them to be severed from their hard plastic connection.

If the compression seal is very tight, rocking the plastic hose end back and forth while holding the air beam inlet may help dislodge the connection.

INCORRECT way to grab hose

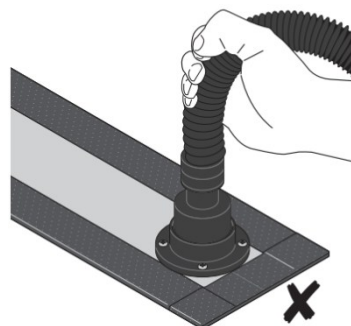

CORRECT way to grab hose

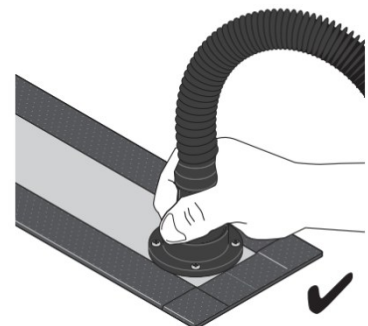

## Exhibit 1: Parts Diagrams

Model: AM1200-VS

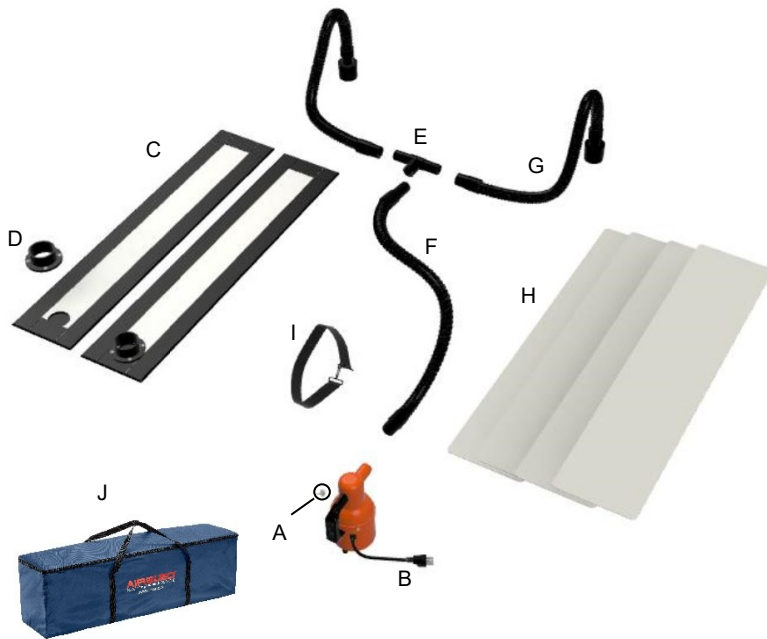

ID	Qty	Part No.	Description
A	1	PA01VS	On/Off variable speed dial
B	1	PA01PC	Power cord
C	2	PA0736	7" W x 36" L x 1/8" T air beams
D	2	PA3INL	Hose inlet with damper gasket
E	1	PA3WAY	Tee connector
F	1	PA01LH	Lead hose
G	2	PA02SH	Supply hose
H	4	PA4RSA8	8" W x 36: L Rough Surface Adapters
I	1	PA01ST	Shoulder strap
J	1	PA04BG	Carry bag for full system
-	1	B1200	Complete blower for AM1200-VS 1.3HP / 120v / 8 amps

Note:  
1.3HP 220v blowers are 4 amps

**LIMITED PRODUCT WARRANTY**

Airsled, Inc. (warrantor) uses the utmost care in the manufacturing of its products, and this is warranted to be free from defects in material and workmanship, subject to the following limitations, qualifications and conditions.

**IDENTITY OF PARTY COVERED BY WARRANTY**

This warranty extends only to the first customer purchaser and not to any subsequent transferee.

**DESCRIPTION AND IDENTIFICATION OF PRODUCT**

This warranty covers the following products of the warrantor; Airsled Appliance Movers.

**WARRANTY STATEMENT**

Airsled, Inc. (warrantor) offers a thirty-day money back satisfaction warranty from the date of purchase, excluding all shipping costs. In the event of a defect, malfunction or failure to conform to this warranty, the warrantor, at its election, will replace or repair such merchandise, including parts and labor, the warrantor shall provide return labels. Defects, malfunctions, failure or damage to the product caused by improper unreasonable or negligent abuse are specifically excluded from this warranty. In the event any repair or modification is done to this product during the term of the warranty by anyone other than the Warrantor, the defect applicable to such repair or modification shall be specifically excluded from this warranty, and Warrantor, in its sole operation, may determine if this exclusion shall be applicable. This warranty shall not apply to expendable parts, filters and the finish of painted parts. If products are returned within the 30-day period with visible signs of heavy usage and/or damage, Airsled reserves the right to withhold 25% of the purchase price to cover repair and refurbishment costs.

**TERM OF WARRANTY**

This warranty shall extend for a period of one (1) year from the date of original purchase by the first consumer purchaser but shall expire prior thereto if the same shall be transferred to another person.

**TO OBTAIN PERFORMANCE OF WARRANTY**

To obtain performance of this warranty obligation, the eligible consumer must deliver the defective product, with shipping and delivery charges prepaid, to:

**Airsled, Inc.  
66 Albe Dr.  
Newark, DE 19702  
Attn: Customer Service Dept.**

The eligible consumer should also provide satisfactory evidence of the purchase date. In the event the defect involves a not too labor intensive or costly correction, the warrantor shall replace or repair the product and return the same to the consumer, with all return shipping and delivery charges prepaid.

**LIMITATION ON REFUND**

The Warrantor reserves the right to elect a refund in lieu of repair or replacement of the product provided the Warrantor is unable to provide replacement and repair is not commercially practical or cannot be timely made.

**EXCLUSION OF ALL OTHER WARRANTIES**

Other than as expressly provided herein, warrantor makes no other warranty express or implied with respect to the product sold. Warrantor makes no warranty of product merchantability and no warranty of fitness of the product for a particular purpose.

**EXCLUSION OF INCIDENTAL OR CONSEQUENTIAL DAMAGES**

This warranty extends only to repair or replacement of the product and does not afford any coverage with respect to incidental or consequential damages, nor shall any claim be greater in amount than the purchase price of the product to which such claim is made. (Some states do not allow the exclusion or limitation of the incidental or consequential damages so that the above limitation or exclusion may not apply to you.)

**ADDITIONAL RIGHTS**

This warranty gives you specific legal rights and you may also have other rights which vary from state to state.

**AIRSLED, INC.**

This warranty is intended to comply with Federal Legislation relating to the contents and terminology in all warranties and shall be construed in a manner of consistent therewith.